

MONTAGEANLEITUNG FÜR KABELDURCHFÜHRUNGSSYSTEM KDS-SR MOUNTING INSTRUCTIONS FOR CABLE ENTRY SYSTEM KDS-SR

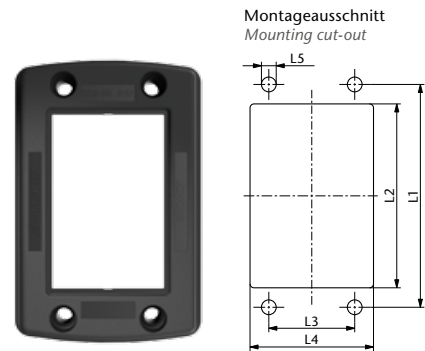

Montageausschnitt
Mounting cut-out

Bei abweichenden Durchbruchmaßen
wird der Rahmen im letzten Schritt
montiert

*In case of alternative cut-out dimensions,
the frame is mounted in the last step*

Rahmen Frame	Best.-Nr. Cat.no.	L1 (mm)	L2 (mm)	L3 (mm)	L4 (mm)	L5 (mm)
KDS-SR 1/4	28506.4	58	46	32	46	5,5
KDS-SR 6/10	28500.4	83	68,5	32	46	5,5
KDS-SR 8/16	28502.4	103	91	32	46	5,5
KDS-SR 10/24	28504.4	130	113,5	32	46	5,5

Zulassung nach UL Standard 508A (File E489821):
Befestigung mit Edelstahlschrauben M5, AISI type 304 oder 316
Maximale Umgebungstemperatur bei UL Applikationen 50 °C
Max. Temperaturbereich: -40 °C bis +120 °C (statisch)



UL Standard 508A (File E489821) the following conditions of acceptability apply:
Mounting with stainless steel screws M5, AISI type 304 or 316
Maximum end use temperature for UL applications 50 °C
Max. temperature range: -40 °C to +120 °C (static)

MONTAGEANLEITUNG FÜR FLANSCHPLATTEN KDS-FP MOUNTING INSTRUCTIONS FOR FLANGE PLATES KDS-FP

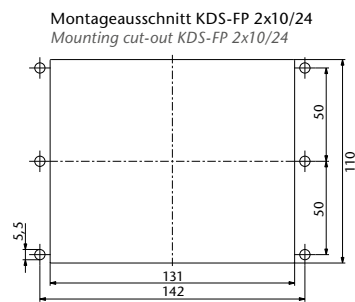

Montageausschnitt KDS-FP 2x10/24
Mounting cut-out KDS-FP 2x10/24

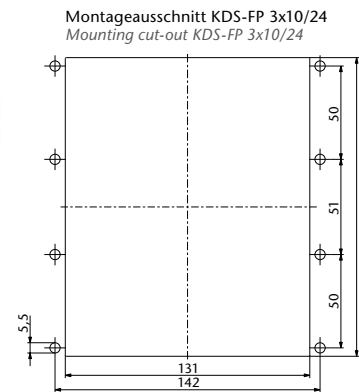

Montageausschnitt KDS-FP 3x10/24
Mounting cut-out KDS-FP 3x10/24

Sollbruchstelle nutzen und Durchbruch erzeugen, um die Flanschplatte zu bestücken
Open a pre-determined breaking point to equip the flange plate

Ohne Werkzeugeinsatz und spanende Bearbeitung auf bis zu 30 Durchlassöffnungen erweiterbar
Can be extended to max. 30 opening, without the use of tools or further machining



BEDIENUNGSANLEITUNG FÜR INLAYS UND DICHELEMENTE IN ANWENDUNG MIT KDS-SR UND KDS-FP OPERATION INSTRUCTIONS FOR MOUNTING INLAYS AND SEALS INTO KDS-SR AND KDS-FP

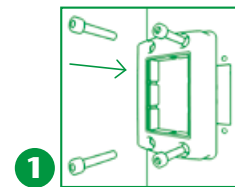

Befestigung der KDS-SR
4 x M5, Anzugsmoment: 3 Nm
Attachment of KDS-SR
4 x M5, Torque: 3 Nm

Befestigung der KDS-FP
6 bzw. 8 x M5, Anzugsmoment: 3 Nm
Attachment of KDS-FP
6 or 8 x M5, Torque: 3 Nm

Schraube M5 ISO 4762 / DIN 912
Screw M5 ISO 4762 / DIN 912

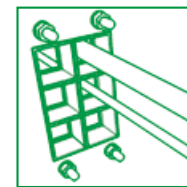
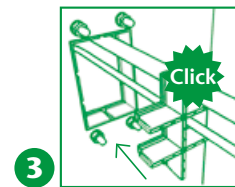
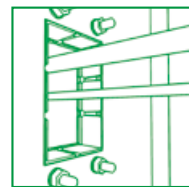
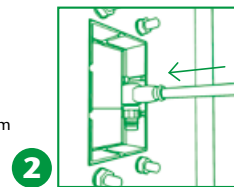

Richtige Montage des Inlays wird mit Klick bestätigt
Correct mounting of the inlay is confirmed by a click

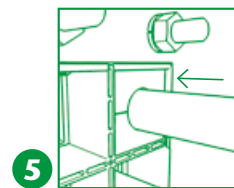
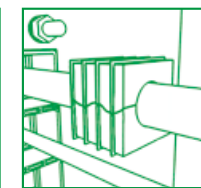
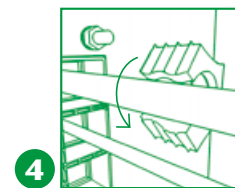

Dichtelement bis zum Ende
eindrücken
Push cable sleeve till the end

Kombinationsmöglichkeiten KDS-SR
Combination options KDS-SR

Rahmen Frame	Inlay			
	1	2	4	6
28516.4	28517.4	28518.4	28519.4	
KDS-SR 1/4			x	
KDS-SR 6/10		x		x
KDS-SR 8/16	x		x	
KDS-SR 10/24		x	x	x

Kombinationsmöglichkeiten KDS-FP
Combination options KDS-FP

Flanschplatte Flange plate	Inlay			
	1	2	4	6
28516.4	28517.4	28518.4	28519.4	
KDS-FP 2x10/24	x	x	x	x
KDS-FP 3x10/24	x	x	x	x

VERRIEGELUNGSRAHMEN / VERRIEGELUNGSELEMENT LOCKING FRAME / LOCKING ELEMENT

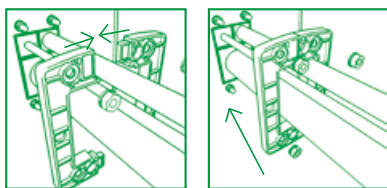

Montage der optionalen Verriegelungsrahmen
des Kabeldurchführungssystems KDS-SR
Optional mounting of locking frame for
cable entry system KDS-SR



Montage der optionalen Verriegelungen
für die Flanschplatten KDS-FP
Optional mounting of inner locks
for flange plates KDS-FP

**MONTAGEANLEITUNG FÜR
KABELEINFÜHRUNGSSYSTEM KES**
MOUNTING INSTRUCTIONS FOR
CABLE ENTRY SYSTEM KES

Max. Temperaturbereich: -40 °C bis +90 °C (statisch)
Max. temperature range: -40 °C to +90 °C (static)



BEDIENUNGSANLEITUNG
OPERATION INSTRUCTIONS

Vor Kabeleinführung Membrane am Durchsteckpunkt einstechen
Pierce the membrane at the push-through point before cable entry



KDS 
CLICK
by CONTA-CLIP

MONTAGE- / BEDIENUNGSANLEITUNG
INSTALLATION / OPERATING INSTRUCTIONS

KES BEFESTIGUNGSVARIANTEN
KES CONNECTION VARIANTS

Schraubenbefestigung von außen
Screw-on mount from the outside

Schraube ISO 4762 / DIN 912
Screw ISO 4762 / DIN 912

4 x M5, Anzugsmoment: 3 Nm
4 x M5, Torque: 3 Nm

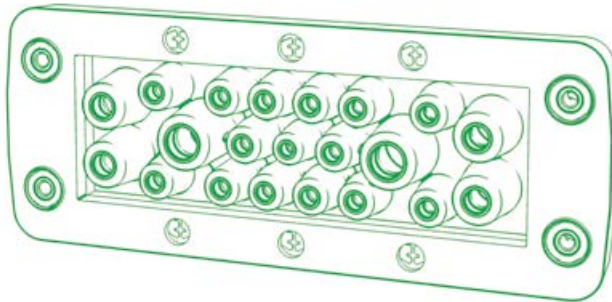

Montageausschnitt
Mounting cut-out

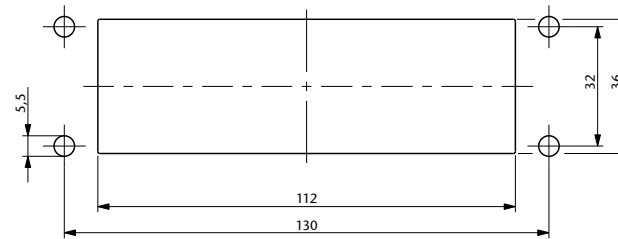

Schraubenbefestigung von innen
mit Gewindebuchsen und Rasthaken
Screw-on mount from the inside with
threaded bushes and latching clips

4 x M4, Anzugsmoment: 2,5 Nm
4 x M4, Torque: 2,5 Nm

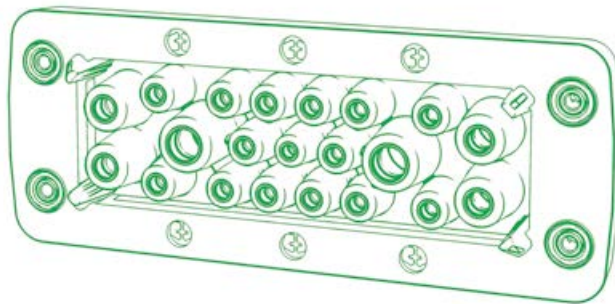

Montageausschnitt
Mounting cut-out

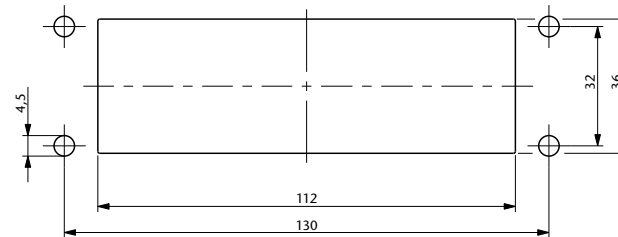

Rastbefestigung mittels Rasthaken
Latched (snap-on) mount using latching hooks

Blechstärke bei Rasthaken 1,5 – 2 mm
Sheet thickness for latching hooks 1,5 – 2 mm

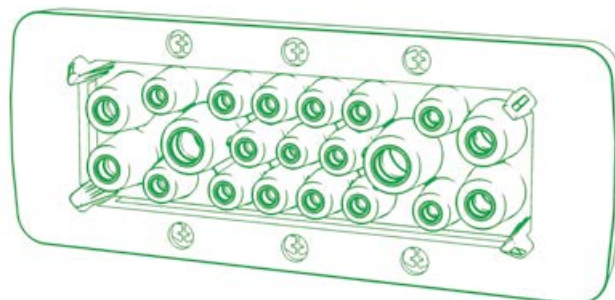

Montageausschnitt
Mounting cut-out

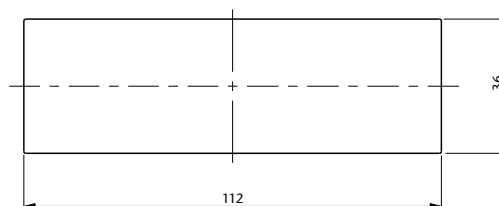

WEITERE INFORMATIONEN
FURTHER INFORMATION
www.conta-clip.com

